



**AT&T**

**AT&T 3B2** Computer  
Random Access Memory  
Expansion Manual



**AT&T**

305-532  
Issue 3

**AT&T 3B2** Computer  
Random Access Memory  
Expansion Manual

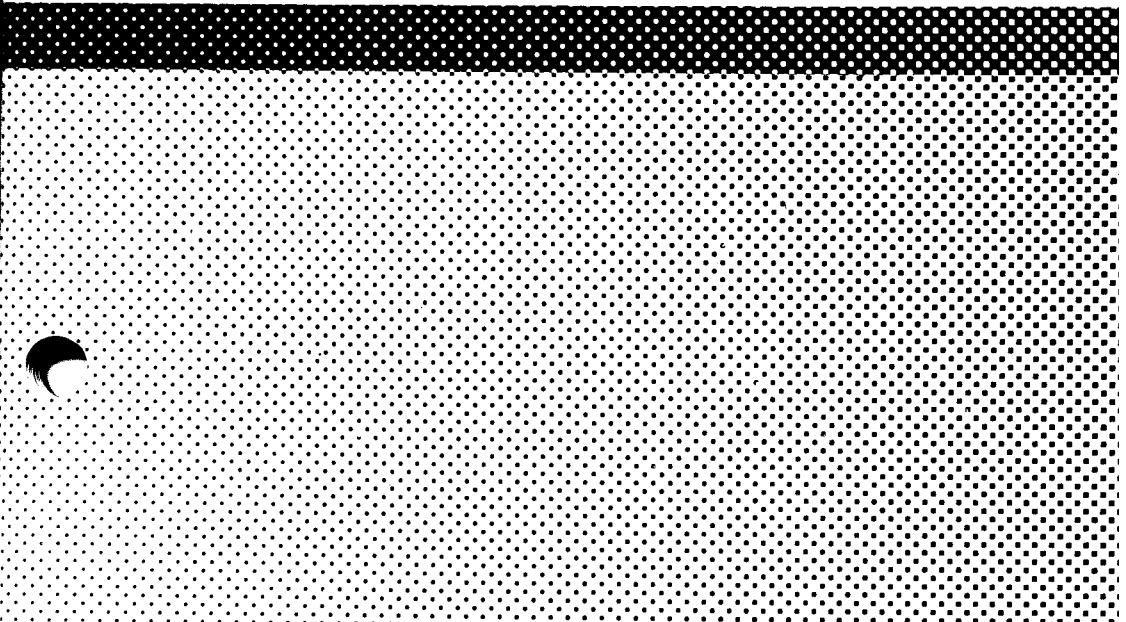

---

## **NOTICE**

The information in this document is subject to change without notice. AT&T assumes no responsibility for any errors that may appear in this document.

Copyright© 1986 AT&T  
All Rights Reserved  
Printed in U.S.A

## **ORDERING INFORMATION**

Additional copies of this document can be ordered by calling

**1-800-432-6600** Inside the U.S.A.

**1-800-255-1242** Inside Canada

OR

**1-317-352-8557** Outside the U.S.A.

OR by writing to:

**AT&T Customer Information Center (CIC)  
Attn: Customer Service Representative  
P.O. Box 19901  
Indianapolis, IN 46219**

# CONTENTS

- Chapter 1. INTRODUCTION**
- Chapter 2. INSTALLATION AND REMOVAL IN A 4-SLOT  
3B2 COMPUTER**
- Chapter 3. INSTALLATION AND REMOVAL IN A  
12-SLOT 3B2 COMPUTER**
- Chapter 4. TESTING AND TROUBLESHOOTING**

# Chapter 1

## INTRODUCTION

	PAGE
<b>FEATURE DESCRIPTION</b> .....	1-1
4-Slot 3B2 Computer Memory Configurations .....	1-2
12-Slot 3B2 Computer Memory Configurations .....	1-3
<b>CONVENTIONS</b> .....	1-4
<b>MANUAL ORGANIZATION</b> .....	1-5
<b>UNPACKING INSTRUCTIONS</b> .....	1-5
<b>IMPORTANT REMINDERS</b> .....	1-8
General .....	1-8
Safety .....	1-8
Hardware .....	1-8

# Chapter 1

---

## INTRODUCTION

This manual describes the Random Access Memory (RAM) Expansion feature of your AT&T 3B2 Computer. Little computer related experience is needed to install or remove the memory cards.

The RAM Expansion feature cards are designed for use in all 3B2 Computers. The operation of the RAM cards is identical for all 3B2 Computers, but the installation and removal procedures for RAM cards are different. Therefore, the installation and removal procedures for 3B2 Computers equipped with four backplane slots (4-slot 3B2) are in Chapter 2, and the installation and removal procedures for 3B2 Computers equipped with twelve backplane slots (12-slot 3B2) are in Chapter 3.

## FEATURE DESCRIPTION

The RAM expansion feature is an optional 3B2 Computer add-on feature that provides additional main memory. Adding main memory improves the efficiency and power of your computer. This feature consists only of 3B2 Computer hardware. There are no additional commands or software included.

In order for you to take full advantage of the RAM installed in your 3B2 Computer, the tunable parameter "NBUF" must be set for the particular amount of RAM in your computer. This parameter will automatically be reset to a specified default value when you perform the installation or removal procedure. Information on manually setting tunable parameters is given in the 3B2 Computer System Administration documentation.

### 4-Slot 3B2 Computer Memory Configurations

The 4-slot 3B2 Computers have five possible configurations of main memory:

- 512 kilobytes — which can be obtained by using two 256-kilobyte memory cards in the computer. 512 kilobytes is the minimum amount of memory provided in a 4-slot 3B2 Computer.
- 1 megabyte — which can be obtained by using one 1-megabyte memory card in the computer.
- 2 megabytes — which can be obtained by using two 1-megabyte memory cards OR one 2-megabyte memory card in the computer.
- 3 megabytes — which can be obtained by using one 2-megabyte memory card and one 1-megabyte memory card in the computer.
- 4 megabytes — which can be obtained by using two 2-megabyte memory cards in the computer.

**Note:** A 256-kilobyte memory card and a 1-megabyte or 2-megabyte memory card **cannot** be used together in any 3B2 Computer.

These are the only combinations that are available. There are no provisions for further memory growth in a 4-slot 3B2 Computer.



## 12-Slot 3B2 Computer Memory Configurations

The 12-slot 3B2 Computer has four possible configurations of main memory:

- 1 megabyte — which can be obtained by using one 1-megabyte memory card in the computer. 1 megabyte is the minimum amount of memory provided in a 12-slot 3B2 Computer.
- 2 megabytes — which can be obtained by using two 1-megabyte memory cards or one 2-megabyte memory card in the computer.
- 3 megabytes — which can be obtained by using one 1-megabyte memory card and one 2-megabyte memory card in the computer.
- 4 megabytes — which can be obtained by using two 2-megabyte memory cards in the computer.

**Note:** 256-kilobyte memory cards **cannot** be installed in the 12-slot 3B2 Computer or the computer will not operate properly.

These are the only combinations that are available. There are no provisions for further memory growth in a 12-slot 3B2 Computer.

### CONVENTIONS

This document contains sample displays which will help you understand described procedures. The sample displays in this document and the displays on your terminal screen may differ slightly due to improvements in the product after this document was finalized. Therefore, use the displays in this document as samples of the type of data available. However, the data displayed on your terminal screen accurately reflects the software on your computer. The following conventions are used to show your terminal input and the system output.

This style of type is used to show system generated responses displayed on your screen.

**This style of bold type is used to show inputs entered from your keyboard that are displayed on your screen.**

These bracket symbols, < > identify inputs from the keyboard that are not displayed on your screen, such as: <CR> carriage return, <CTRL d> control d, <ESC g> escape g, passwords, and tabs.

*This style of italic type is used for notes that provide you with additional information.*

**Note:** Throughout this document, the terms "4-slot 3B2" and "12-slot 3B2" are used. The term "4-slot 3B2" refers to a 3B2 Computer that is equipped with four backplane slots (3B2/300 and 3B2/310 Computers). The term "12-slot 3B2" refers to a 3B2 Computer that is equipped with 12 backplane slots (3B2/400 Computer).

## MANUAL ORGANIZATION

The remainder of this feature manual is divided into the following chapters:

- Chapter 2, "INSTALLATION AND REMOVAL IN A 4-SLOT 3B2 COMPUTER," describes how to install or remove memory cards in a 4-slot 3B2 Computer.
- Chapter 3, "INSTALLATION AND REMOVAL IN A 12-SLOT 3B2 COMPUTER," describes how to install or remove memory cards in a 12-slot 3B2 Computer.
- Chapter 4, "TESTING AND TROUBLESHOOTING," describes how to clear trouble you may have with your memory cards.

Refer to your appropriate *AT&T 3B2 Computer Owner/Operator Manual* for a glossary of abbreviations and terms also used in this manual.

## UNPACKING INSTRUCTIONS

If you have not already done so, inspect the shipping container for signs of damage before unpacking the memory card(s). If any damage is suspected, notify the shipper immediately. The shipper may suggest that you unpack the container and check its contents for damage. Keep in mind that even though damage to the contents may not be obvious, some internal damage may have occurred.

The following steps describe how to properly unpack and visually inspect your memory card(s).

1. Carefully remove the contents of the shipping container.
2. Check the contents of the shipping container against the packing invoice to ensure that no items are missing. The following items should be present in the shipping container.

- The proper number of RAM cards
- One *AT&T 3B2 Computer Random Access Memory Expansion Manual*.

**Caution:** *While handling a memory card, do not wear any metal rings, and always hold a card by the edges—like a record album. The components on the memory card are sensitive to static discharge and could be damaged if not handled carefully.*

3. Carefully remove the protective packing from around your memory card(s). The contacts have been cleaned and lubricated by the manufacturer and should not require additional cleaning.
4. Inspect each card for damage that may have occurred during shipment (loose components, cracks, etc). If any damage occurred, immediately notify the shipper and either your AT&T Service Representative or authorized dealer.
5. Verify that the memory card(s) you received is what you ordered by checking the identification number on the back side of the card. The possible locations for the identification number are shown in Figure 1-1.
  - The 256-kilobyte memory cards are stamped 191A. (Location A of Figure 1-1.)
  - The 1-megabyte memory cards are stamped 191B. (Location A of Figure 1-1.)
  - The 2-megabyte memory cards for the 12-slot 3B2 are stamped 192B. (Location A of Figure 1-1.)

- The 2-megabyte memory cards for the 4-slot or 12-slot 3B2 are stamped CM191D. (Location B of Figure 1-1.) These cards have components mounted on both sides of the circuit board.

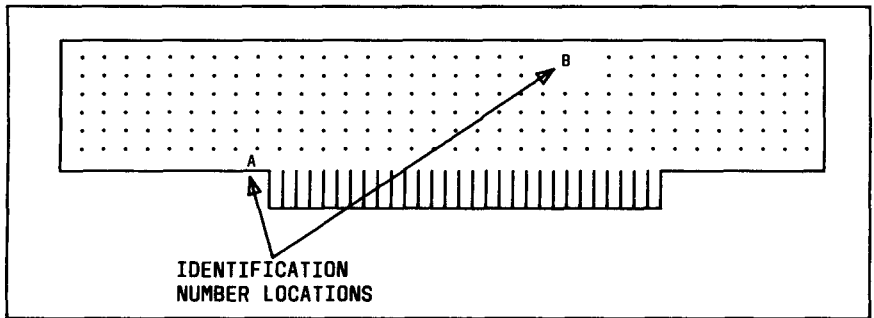

**Figure 1-1. Location of Memory Card Identification Number**

Check your receipt to make sure the correct card was ordered. If there is a problem, contact your AT&T Service Representative or authorized dealer.

6. Save the packing material in case the memory card(s) must be repacked in the future.

## IMPORTANT REMINDERS

### General

1. Be familiar with your appropriate *AT&T 3B2 Computer Owner/Operator Manual* and this manual **BEFORE** installing this feature.
2. Keep this manual handy in your computer library. Store it with your other soft-cover feature manuals in your *Options* binder.

### Safety

1. Be alert for sharp edges when handling hardware.
2. Always follow the prescribed powerdown procedures and unplug your 3B2 Computer before removing the cover.
3. Follow instructions carefully to avoid personal injury or equipment damage.

### Hardware

1. Protect your feature hardware from:

Sunlight	Chemicals
Heat	Breakage
Cold	Grime
Static Electricity	
2. Do not disturb other 3B2 Computer hardware.
3. Use tools in the proper manner.

## Chapter 2

### INSTALLATION AND REMOVAL IN A 4-SLOT 3B2 COMPUTER

	PAGE
HARDWARE REQUIREMENTS .....	2-1
SOFTWARE REQUIREMENTS .....	2-2
PREPARATION .....	2-2
HARDWARE INSTALLATION AND REMOVAL .....	2-3
SOFTWARE INSTALLATION AND REMOVAL .....	2-12

## Chapter 2

---

### INSTALLATION AND REMOVAL IN A 4-SLOT 3B2 COMPUTER

This chapter provides instructions on how to install and remove Random Access Memory (RAM) expansion feature cards in your 4-slot 3B2 Computer (3B2/300 or 3B2/310 Computer).

#### HARDWARE REQUIREMENTS

256-kilobyte, 1-megabyte, and 2-megabyte RAM cards may be used in a 4-slot 3B2 Computer. However, the 256-kilobyte memory card **cannot** be installed in the computer with a 1-megabyte or 2-megabyte card. Detailed information on allowable RAM card combinations is given later in this chapter.



### SOFTWARE REQUIREMENTS

The only software requirement is that the tunable parameter "NBUF" must be reconfigured whenever the amount of RAM in the computer is changed. The hardware installation and removal instructions include steps that will cause the computer to automatically reconfigure this parameter. However, to get the greatest efficiency from your RAM cards, some tunable parameters should be changed to their recommended values. See your 3B2 Computer System Administration documentation for information on setting tunable parameters.

### PREPARATION

Estimated time for installation is between 15 and 30 minutes. If the RAM card(s) was installed for you, only perform Steps 1 and 2 in the "HARDWARE INSTALLATION AND REMOVAL" procedure. Then power up the computer according to your *AT&T 3B2 Computer Owner/Operator Manual*.

Before installing or removing any hardware, do the following:

- Obtain a small flathead screwdriver.
- Have your *AT&T 3B2 Computer Owner/Operator Manual* handy.
- Review the "IMPORTANT REMINDERS" discussed in Chapter 1.

If you follow each step carefully, installing or removing RAM cards will be relatively easy. Read the appropriate installation and removal procedure, and make sure you understand each step before you begin.

## HARDWARE INSTALLATION AND REMOVAL

RAM cards are designed so they are easy to install or remove. If you have any trouble installing or removing a card, **do not force it**. Whenever you insert a RAM card, make sure that you position the card as described in this chapter and that you are inserting it into the proper connector.

***Warning: It is possible to install a RAM card backwards. Installing a RAM card backwards and applying power MAY permanently damage the card or prevent the computer from powering up. If you are uncertain about any part of the installation procedure, do not attempt to install the RAM card(s). Contact your AT&T Service Representative or authorized dealer.***

The contacts of your new RAM card(s) have been cleaned and lubricated by the manufacturer. Do not clean the contacts before installing the RAM card.

Every time the amount of RAM in your 3B2 Computer is changed (increased or decreased), the value of the tunable parameter "NBUF" must be reset. Otherwise, the system could panic. Therefore, it is recommended that you execute the following procedures exactly as described whenever the amount of RAM is changed.

## INSTALLATION AND REMOVAL IN A 4-SLOT 3B2 COMPUTER

---

When you install or remove RAM cards in your 4-slot 3B2 Computer, perform the following steps:

1. With the 3B2 Computer on, log on at the console as **root** and perform either Step a or b:
  - a. If you are installing RAM cards in a 3B2/300 Computer, enter the following commands:

```
touch /etc/system<CR>  
shutdown -y -g90 -i0<CR>
```

The computer will shut down with a 90-second grace period, and tunable parameters associated with RAM will be automatically reconfigured when the computer is powered up.

- b. If you are installing RAM cards in a 3B2/310 Computer, shut down your computer according to the procedure given in the *AT&T 3B2 Computer Owner/Operator Manual*.

***Caution: Never pull the power plug or externally remove power until the 3B2 Computer has completed its shutdown sequence. Data could be permanently lost if the computer is not shut down properly.***

## INSTALLATION AND REMOVAL IN A 4-SLOT 3B2 COMPUTER

---

2. Wait for the computer to complete its shutdown sequence. The broadcast message will end with "The system is down", and the POWER indicator will turn off.
3. Unplug the power cord.
4. Remove the cable access door. To remove, release the latch, lift the door, and pull up. See Figure 2-1.

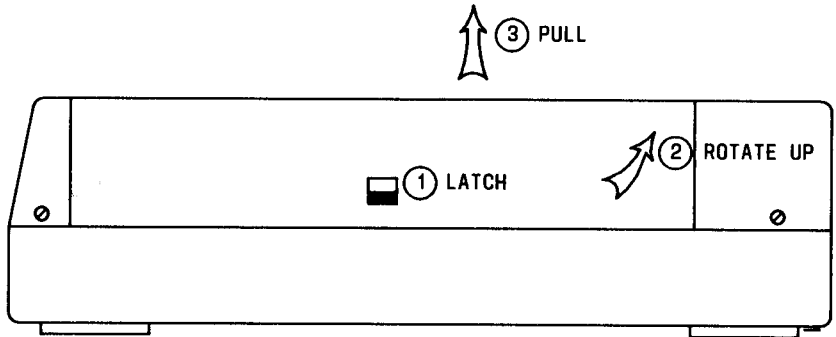

**Figure 2-1. Removing Cable Access Door**

5. Remove the four screws holding the computer cover.
6. Remove the computer cover.

## INSTALLATION AND REMOVAL IN A 4-SLOT 3B2 COMPUTER

---

7. Compare Figure 2-2 to the inside of your 3B2 Computer so you will be familiar with the location and placement of your RAM cards.
8. Loosen the screw on the bracket holding the RAM card(s) in place (Figure 2-2).
9. Slide the bracket up and remove it from the apparatus mounting.

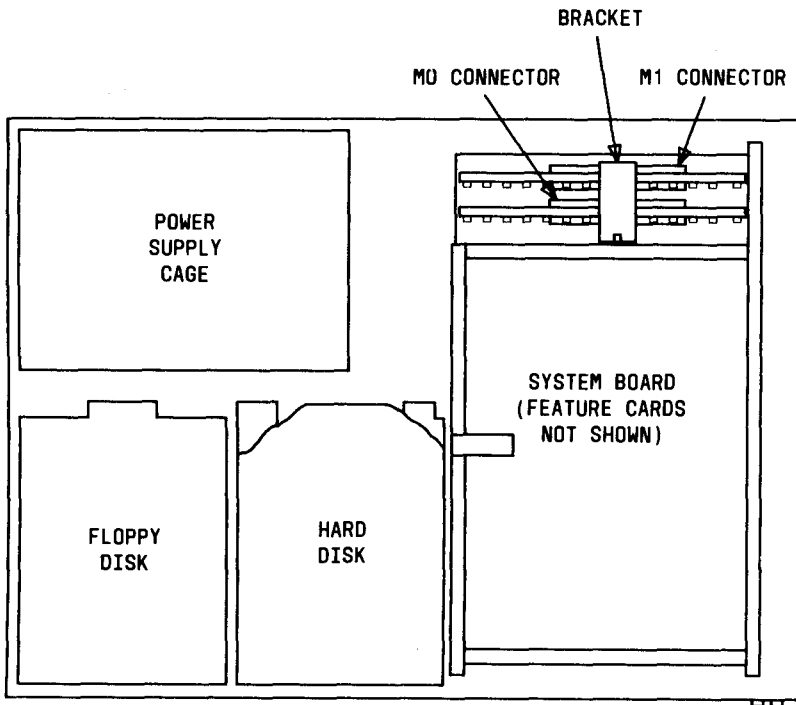

**Figure 2-2. Inside View of a 4-Slot 3B2 Computer**

10. Using Figure 2-3, determine the RAM card layout that you want in your 4-slot 3B2 Computer.

**Warning:** RAM cards for your 4-slot 3B2 Computer must be installed according to Figure 2-3. If you do not install the appropriate RAM cards in the appropriate connectors, your computer will not operate properly. No other RAM card combinations may be used.

TOTAL AMOUNT OF RAM	RAM CARD PLACEMENT	
	M0 CONNECTOR	M1 CONNECTOR
512 kilobytes	256-kilobyte card	256-kilobyte card
1 megabyte	1-megabyte card	---
2 megabytes	1-megabyte card	1-megabyte card
	2-megabytes	---
3 megabytes	2-megabyte card	1-megabyte card
4 megabytes	2-megabyte card	2-megabyte card

**Figure 2-3. Possible RAM Card Configurations for 4-Slot 3B2 Computers**

11. If you have to remove a RAM card from its connector slot so that it can be replaced by another RAM card or moved to the other connector slot, perform the following steps:
  - a. Locate the RAM card you want to remove. (See Figure 2-2.) Notice that the component side of the card faces toward the front of the cabinet.

## INSTALLATION AND REMOVAL IN A 4-SLOT 3B2 COMPUTER

---

- b. Remove the RAM card from its connector by carefully holding the card by its edges and slowly pulling the card straight up.
  - c. Carefully place the card aside.
  - d. If you want to remove another RAM card, repeat Steps a, b, and c.
12. If you are installing RAM cards in the computer, perform the following steps:

**Caution:** *Never install a 256-kilobyte RAM card and a 1-megabyte or 2-megabyte RAM card together in your 3B2 Computer. The computer will not operate properly with this combination of RAM cards.*

- a. Carefully pick up, by its edges, the RAM card to be installed.
- b. If the RAM card has a plastic sleeve over the contacts, remove the plastic sleeve.

**Warning:** *Failure to install a RAM card exactly as outlined in this procedure may permanently damage the card or prevent the computer from powering up when power is applied. The front side of an installed RAM card must face the front of the 3B2 Computer cabinet. Figure 2-4 shows the front side of a 256-kilobyte RAM card. (Notice that the right-hand end of the card is longer than the left-hand end of the card from the edge of the card to the connector pins.)*

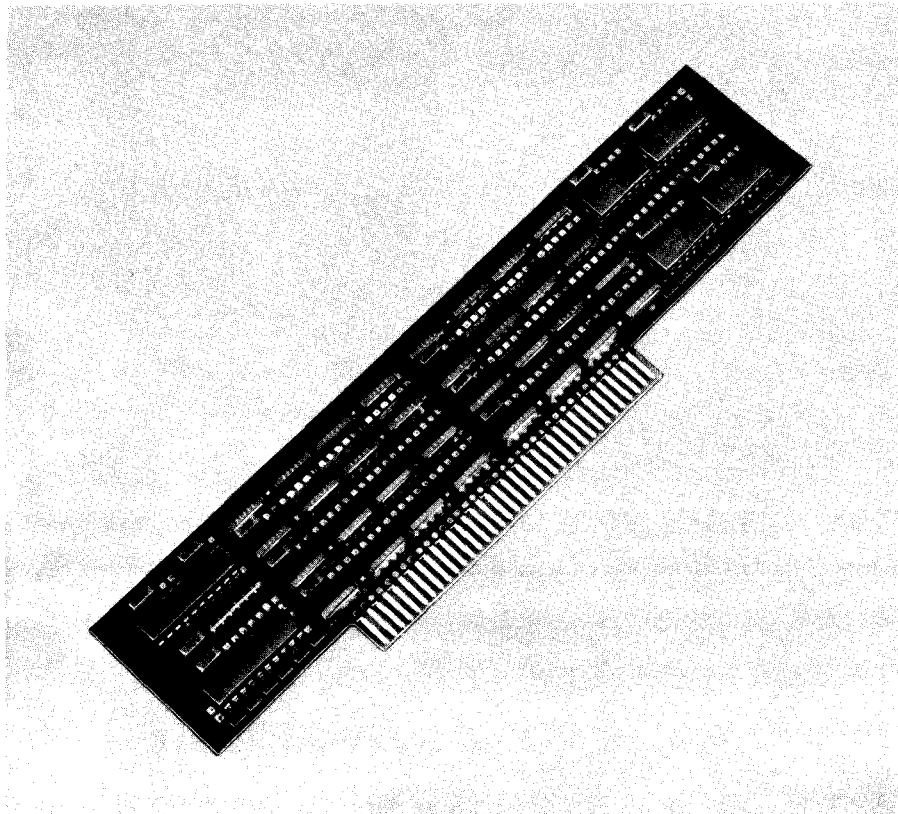

**Figure 2-4. Front Side of a 256-Kilobyte RAM Card**

**Note:** The identification number is always stamped on the **BACK** side of a RAM card. (Figure 2-5 shows the back of a 2-megabyte RAM card. Notice the identification number along the top edge of the card.) Use the identification number and the longer right-hand end of a card as references to determine the front side of a RAM card.



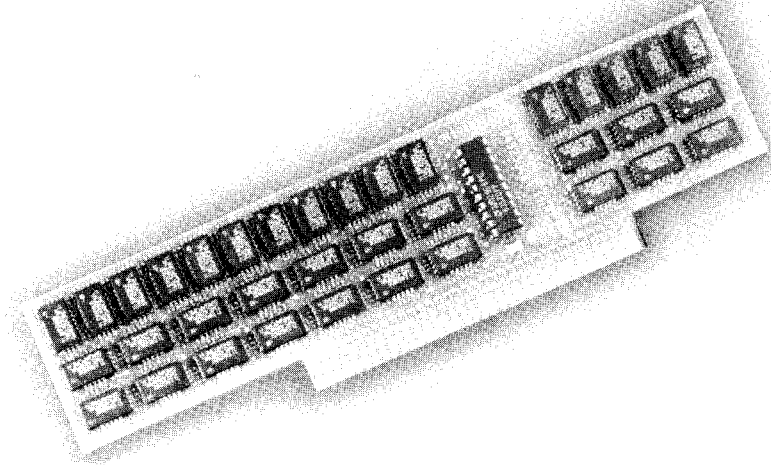

**Figure 2-5. Back Side of a 2-Megabyte RAM Card**

- c. With the front side facing toward the front of the cabinet, hold the RAM card over the appropriate connector. See Figure 2-2 to determine the location and identification of each connector.
- d. Gently push the card into its connector until it is firmly in place.
- e. If you are installing another RAM card, repeat Steps a through d.

**Note:** Anytime that the 3B2 Computer contains only one RAM card, it should be installed in the M0 connector slot and the M1 connector slot should be left empty. See Figures 2-2 and 2-3.

13. Place the bracket on top of the RAM card(s), and slide the bracket down onto the screw attached to the mounting apparatus.
14. Tighten the screw to lock the bracket in place.
15. With your new RAM card(s) now installed, carefully place the cover back on the 3B2 Computer.
16. Install the four screws that hold the top cover in place.
17. Place the cable access door back on the computer, and lock the slide latch.
18. Plug in the power cord.
19. If you replaced any RAM cards:
  - a. Place the plastic sleeve from the new RAM card(s) over the contacts on the replaced RAM card(s).
  - b. Carefully pack the card(s), and store it in a safe, cool place.

The hardware installation is now complete. You should be able to apply power to your 3B2 Computer.

## **SOFTWARE INSTALLATION AND REMOVAL**

There is no software to install or remove when you change the amount of Random Access Memory. However, anytime that you change the amount of RAM, the system must be reconfigured. If you performed the "HARDWARE INSTALLATION AND REMOVAL" procedures as described in this chapter, the system will be reconfigured automatically.

## Chapter 3

# INSTALLATION AND REMOVAL IN A 12-SLOT 3B2 COMPUTER

	PAGE
HARDWARE REQUIREMENTS .....	3-1
SOFTWARE REQUIREMENTS .....	3-1
PREPARATION .....	3-2
HARDWARE INSTALLATION AND REMOVAL .....	3-2
SOFTWARE INSTALLATION AND REMOVAL .....	3-11

## Chapter 3

---

# INSTALLATION AND REMOVAL IN A 12-SLOT 3B2 COMPUTER

This chapter provides instructions on how to install and remove Random Access Memory (RAM) expansion feature cards in your 12-slot 3B2 Computer (3B2/400 Computer).

## HARDWARE REQUIREMENTS

Only 1-megabyte and 2-megabyte RAM cards may be used in 12-slot 3B2 Computers. Detailed information on the allowable combinations is given later in this chapter.

## SOFTWARE REQUIREMENTS

There are no specific software requirements for changing RAM cards. However, to get the greatest efficiency from your RAM cards, some tunable parameters should be changed to recommended values. See your 3B2 Computer System Administration documentation for information on setting tunable parameters.

### PREPARATION

Estimated time for installation is between 15 and 30 minutes. Before installing or removing any hardware, do the following:

- Obtain a small flathead screwdriver.
- Obtain a small Phillips head screwdriver.
- Have your *AT&T 3B2/400 Computer Owner/Operator Manual* handy.
- Review the "IMPORTANT REMINDERS" discussed in Chapter 1.

If you follow each step carefully, installing or removing RAM cards will be relatively easy. Read the appropriate installation and removal procedure and make sure you understand each step before you begin.

### HARDWARE INSTALLATION AND REMOVAL

RAM cards are designed so they are easy to install or remove. If you have any trouble installing or removing a card, **do not force it**. Whenever you install a RAM card, make sure that you position it as described in this chapter and that you are inserting it into the proper connector.

**Warning:** *It is possible to install a RAM card backwards. Installing a RAM card backwards and applying power MAY permanently damage the card or prevent the computer from powering up. If you are uncertain about any part of the installation procedure, do not attempt to install the RAM card(s). Contact your AT&T Service Representative or authorized dealer.*

The contacts of your new RAM card(s) have been cleaned and lubricated by the manufacturer. Do not clean the contacts before installing the RAM card(s).

Every time the amount of RAM in your 3B2 Computer is changed (increased or decreased), the value of the tunable parameter "NBUF" is set to the default value for the new amount of RAM. The other tunable parameters are not changed. Information on changing tunable parameters is given in the *AT&T 3B2 Computer System Administration Utilities Guide*.

To install or remove RAM cards in your 12-slot 3B2 Computer, perform the following steps:

1. Shut down your computer according to the procedure given in the *AT&T 3B2/400 Computer Owner/Operator Manual*.

**Caution:** *Never pull the power plug or externally remove power until the 3B2 Computer has completed its shutdown sequence. Data could be permanently lost if the computer is not shut down properly.*

2. Wait for the computer to complete its shutdown sequence. The broadcast message will end with "*The system is down,*" and the POWER indicator will turn off.
3. Unplug the power cord.

## INSTALLATION AND REMOVAL IN A 12-SLOT 3B2 COMPUTER

---

4. Remove the cable access door. To remove, release the latch, lift the door, and pull up. See Figure 3-1.

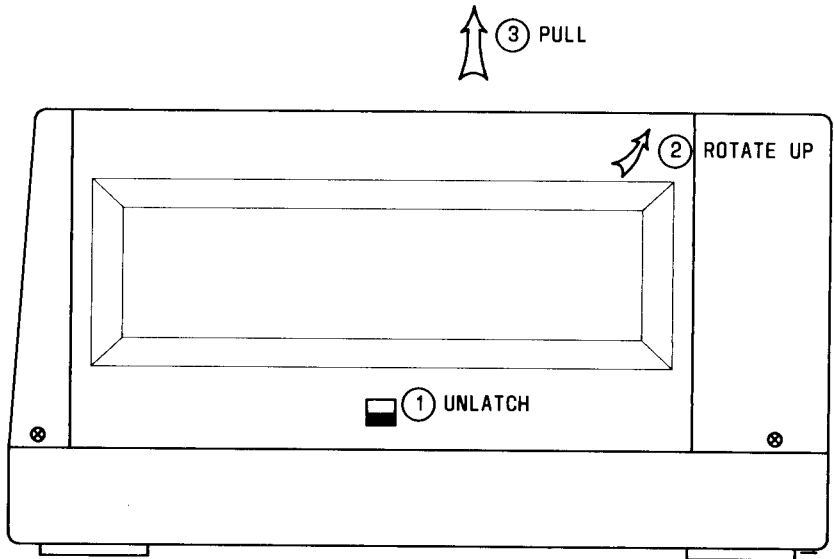

**Figure 3-1. Removing Cable Access Door**

5. Remove the four screws holding the computer cover.
6. Remove the computer cover.



## INSTALLATION AND REMOVAL IN A 12-SLOT 3B2 COMPUTER

7. Compare Figure 3-2 to the inside of your 12-slot 3B2 Computer so you will be familiar with the location and placement of your RAM cards.

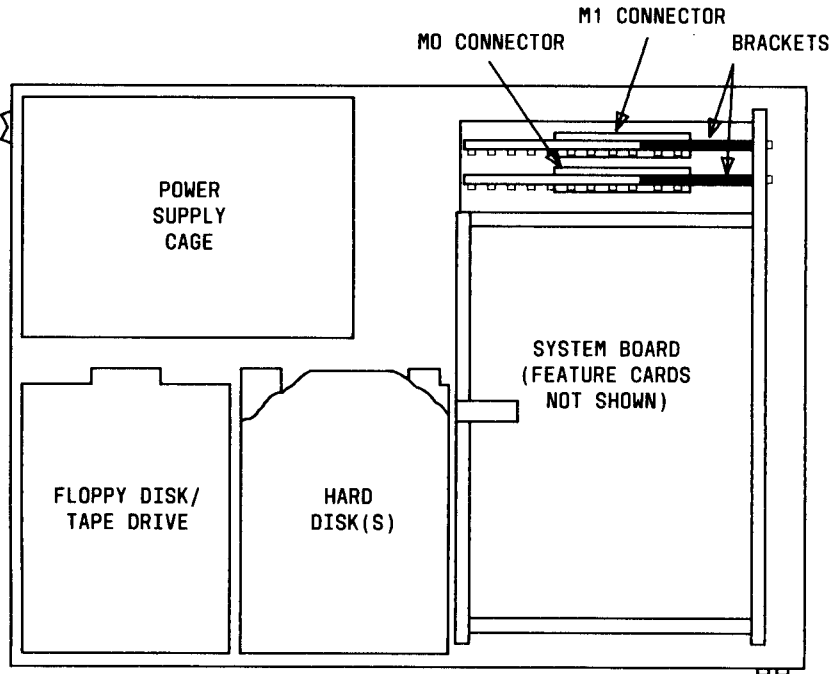

**Figure 3-2. Inside View of the 12-Slot 3B2 Computer**

8. Using Figure 3-3, determine the RAM card layout that you want in your 12-slot 3B2 Computer.

***Warning: RAM cards for your 12-slot 3B2 Computer must be installed according to Figure 3-3. If you do not install the appropriate RAM cards in the appropriate connectors, your computer will not operate properly. No other RAM card combinations may be used.***

TOTAL AMOUNT OF RAM	RAM CARD PLACEMENT	
	M0 CONNECTOR	M1 CONNECTOR
1 megabyte	1-megabyte card	---
2 megabytes	1-megabyte card	1-megabyte card
	2-megabyte card	---
3 megabytes	2-megabyte card	1-megabyte card
4 megabytes	2-megabyte card	2-megabyte card

**Figure 3-3. Possible RAM Card Configurations for a 12-Slot 3B2 Computer**

9. If you have to remove a RAM card from its connector slot so that it can be replaced by another RAM card or moved to the other connector slot, perform the following steps:
  - a. Locate the RAM card you want to remove. (See Figure 3-2.) Notice that the component side of the card faces toward the front of the 3B2 Computer cabinet.
  - b. Loosen the screw on the bracket holding the RAM card in place (Figure 3-2).

## INSTALLATION AND REMOVAL IN A 12-SLOT 3B2 COMPUTER

---

- c. Slide the bracket up and remove it from the apparatus mounting.
- d. Remove the RAM card from its connector by carefully holding the card by its edges and slowly pulling the card straight up.
- e. Carefully place the card aside.
- f. If you want to remove another RAM card, repeat Steps a through e.

***Warning: Failure to install a RAM card exactly as outlined in this procedure may permanently damage the card or prevent the computer from powering up when power is applied. The front side of an installed RAM card must face the front of the 3B2 Computer cabinet. Figure 3-4 shows the front side of a 2-megabyte RAM card that is used only in the 12-slot 3B2 Computer. (Notice that the right-hand end of the card is longer than the left-hand end of the card from the edge of the card to the connector pins.)***

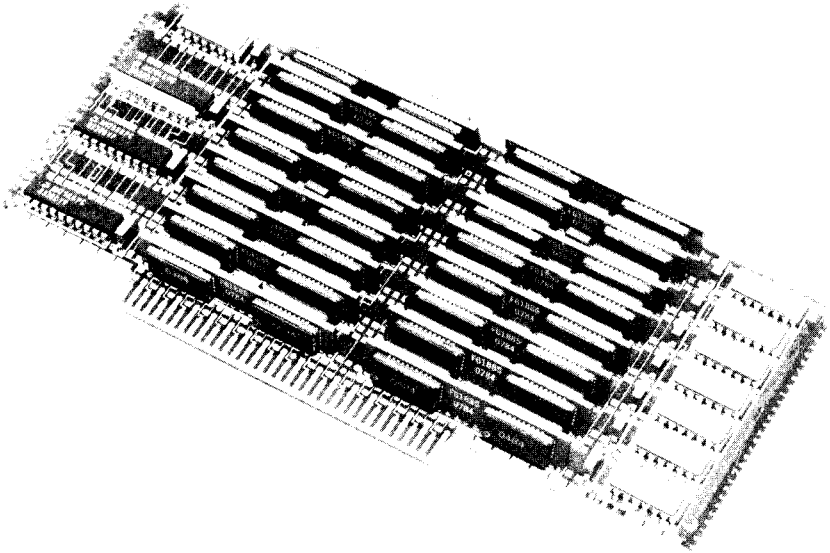

**Figure 3-4. Front Side of a 2-Megabyte RAM Card (12-Slot 3B2 Only)**

**Note:** The identification number is always stamped on the **BACK** side of a RAM card. Figure 3-5 shows the back side of a 2-megabyte RAM card used in both 4-slot and 12-slot 3B2 Computers. Use the identification number and the longer right-hand end of a card as references to determine the front side of a RAM card.

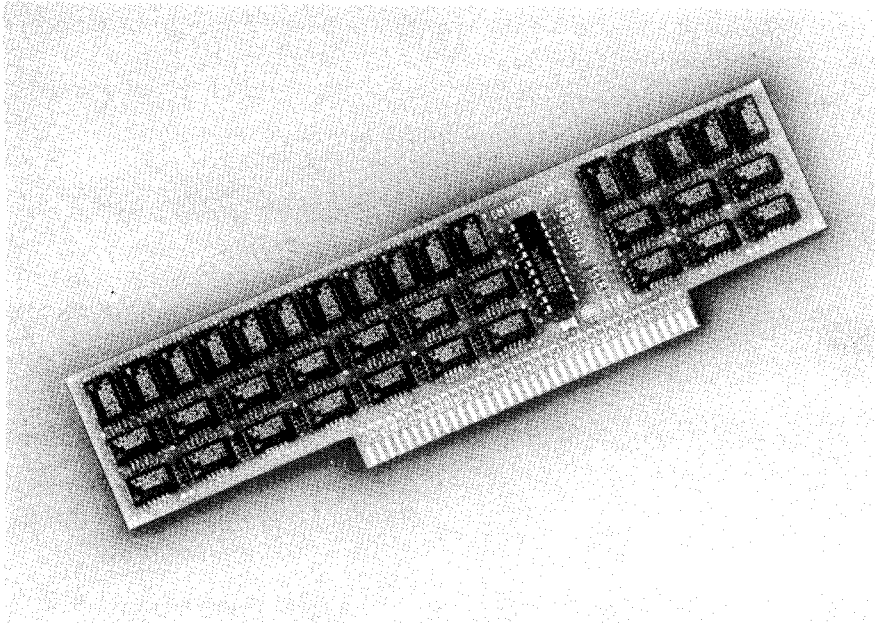

**Figure 3-5. Back Side of a 2-Megabyte RAM Card**

10. If you are installing RAM cards in the computer, perform the following steps:
  - a. If there is a bracket over the slot where the RAM card will be installed, loosen the screw on the bracket, slide the bracket up, and remove it from the apparatus mounting (Figure 3-2).
  - b. Carefully pick up, by its edges, the RAM card to be installed.
  - c. If the RAM card has a plastic sleeve over the contacts, remove the plastic sleeve.

## INSTALLATION AND REMOVAL IN A 12-SLOT 3B2 COMPUTER

---

- d. With the front side facing toward the front of the 3B2 Computer cabinet, hold the RAM card over the appropriate connector. See Figure 3-2 to determine the location and identification of each connector.

***Warning: Do not install your RAM card backwards. It may be damaged or prevent your computer from powering up when power is applied.***

- e. Gently push the card into its connector until it is firmly in place.
- f. Place the bracket on top of the RAM card, and slide the bracket down onto the screw attached to the mounting apparatus.
- g. Tighten the screws to lock the bracket in place.
- h. If another RAM card is to be installed, repeat Steps a through g.

***Note:*** Anytime that the 3B2 Computer contains only one RAM card, it should be installed in the M0 connector slot, and the M1 connector slot should be left empty. See Figures 3-2 and 3-3.

11. With your new RAM cards now installed, carefully place the cover back on the 3B2 Computer.
12. Install the four screws that hold the computer cover in place.
13. Place the cable access door back on the computer and lock the slide latch.
14. Plug in the power cord.

15. If you replaced a RAM card:
  - a. Place the plastic sleeve from the new RAM card(s) over the contacts on the replaced RAM card(s).
  - b. Carefully pack the card(s) and store it in a safe, cool place.

The hardware installation is now complete. You should be able to apply power to the 3B2 Computer.

### **SOFTWARE INSTALLATION AND REMOVAL**

There is no software to install or remove when you change the amount of Random Access Memory. However, anytime that you change the amount of RAM, the system must be reconfigured. If you performed the "HARDWARE INSTALLATION AND REMOVAL" procedures as described in this chapter, the system will be reconfigured automatically.

## Chapter 4

# TESTING AND TROUBLESHOOTING

	PAGE
TESTING .....	4-1
TRUBLESHOOTING .....	4-2
Possible Problems .....	4-2
Procedure for Checking RAM Cards .....	4-3





## Chapter 4

---

# TESTING AND TROUBLESHOOTING



This chapter provides information on testing and troubleshooting problems with Random Access Memory (RAM) cards.

## TESTING

The only tests performed on the new RAM cards are the diagnostic tests which are performed during the normal powerup procedures. Refer to the *AT&T 3B2 Computer Owner/Operator Manual* for the normal powerup procedures.

If your 3B2 Computer fails the diagnostic tests during powerup or will not powerup at all, proceed to "TROUBLESHOOTING."

## **TROUBLESHOOTING**

This section on troubleshooting needs to be used only if your 3B2 Computer was working correctly before you installed new RAM cards and will not power up correctly after installing the new RAM cards.

### **Possible Problems**

If the computer will not powerup at all, check for obvious problems such as: a blown fuse, the power is off on the terminal, the power cord is not connected, etc. Once the obvious problems have been eliminated, check to see that you did not install a RAM card backwards. If installed backwards, some RAM cards will prevent the computer from powering up.

If the computer powered up incorrectly after installing the new RAM cards, check the possible problems listed below:

- The tunable parameters were not reconfigured when the RAM cards were changed.
- A RAM card was not installed properly.
- The contacts on the RAM card(s) need recleaning.
- The RAM card connectors inside the 3B2 Computer need cleaning.
- A RAM card is defective.
- The problem is not related to the RAM cards.

## Procedure for Checking RAM Cards

If all the obvious problems have been checked and you still have trouble, the problem may be the value of the tunable parameter "NBUF." Every time the amount of RAM in your 3B2 Computer is changed (increased or decreased), the value of "NBUF" should be reset to the default value for the new amount of RAM; otherwise, the system could panic.

### *Automatically Reconfiguring the System*

3B2/310 and 3B2/400 Computers automatically reset the tunable parameter "NBUF" to the default value whenever the amount of RAM is changed. However, to automatically reset "NBUF" in a 3B2/300 Computer, the command "**touch /etc/system**" must be executed before the RAM cards are changed. If you changed the amount of RAM in a 3B2/300 Computer but you did not execute the command "**touch /etc/system**" before you changed RAM cards, perform the steps given in (1) or (2):

1. If the system panics or does not initialize correctly, a "SYSTEM FAILURE" error message will be displayed on the screen, and the computer will go to the firmware mode. To correct this problem, do the following:
  - a. Enter the firmware password (default is **mcp**). Note that the password is not echoed on the terminal. The terminal will respond with the message:

---

```
Enter name of program to execute[ ]:
```

- b. You should then enter:

```
/etc/system<CR>
```

The terminal will respond with a message such as:

```
Possible load devices are:
Option Number      Slot      Name
-----
      0             0      FD5
      1             0      HDXX
      .             .
      .             .
Enter Load Device Option Number [  ]:
```

- c. You should then enter:

```
1<CR> (for hard disk)
```

The program will begin executing, and information about the system configuration and load map will be displayed. After displaying this information, the system is automatically rebooted, and the system configuration is reset for the new amount of RAM. When the message:

```
The system is ready.
```

```
Console Login:
```

is displayed, you may log on and return the computer to its normal operating state.

2. If the "touch" command was not executed on the `/etc/system` file and the system happens to initialize correctly, reconfigure the system by entering the following commands:

```
touch /etc/system<CR>
shutdown -y -g0 -i6<CR>
```

The system will automatically shut down and then reboot. This causes the system configuration to be reset for the new amount of RAM. When the message:

```
The system is ready.
```

```
Console Login:
```

is displayed, you may log on and return the computer to its normal operating state.

### ***Checking for Hardware Problems***

If the problem with the computer was not corrected by the procedure given in "Automatically Reconfiguring the System," perform the following steps:

1. Set the POWER switch to STANDBY on your 3B2 Computer and wait for the soft shutdown sequence to complete.
2. Remove the computer cover of your 3B2 Computer. Refer to Chapter 2 or Chapter 3 for instructions on removing the cover.

3. Check to see if the RAM card(s) is properly installed. See Figure 2-2, 2-3, and 2-4 to check a 4-slot 3B2 Computer; and see Figure 3-2, 3-3, and 3-4 to check a 12-slot 3B2 Computer.
  - a. If the card(s) is installed backwards, it is probably damaged.
  - b. If there is only one card and it is installed in the wrong connector, the computer will not operate properly.
4. Clean the contacts on the RAM card(s) and the card connectors by using a soft cotton cloth and a solvent cleaner especially designed to clean contacts.

***Warning: Do not use a cleaner-lubricant which contains silicone.***

5. Install the RAM cards according to the instructions given in Chapter 2 or Chapter 3.
6. Place the cover back on your 3B2 Computer.
7. Power up your 3B2 Computer according to the procedure given in the *AT&T 3B2 Computer Owner/Operator Manual*.
8. If your 3B2 Computer will not power up properly, check for other common problems listed in the *AT&T 3B2 Computer Owner/Operator Manual*.

9. If your 3B2 Computer still does not power up properly, use the procedures given in Chapter 2 or Chapter 3 to replace the new RAM cards with the original RAM cards, and try to power up the computer again. If the computer does power up properly, the new RAM card(s) is defective.
10. If you still cannot power up your 3B2 Computer, contact your local AT&T Service Representative or authorized dealer.

***Warning: Do not try to repair a RAM card on your own. The card can only be repaired by authorized personnel.***

# Index

---

## A

Automatically Reconfiguring the System ..... 4-3

## F

FEATURE DESCRIPTION ..... 1-1

Figure 1-1

Location of Memory Card Identification Number ..... 1-7

Figure 2-1

Removing Cable Access Door — 3B2/300 and 3B2/310 Computer 2-5

Figure 2-2

Inside View of a 4-Slot 3B2 Computer ..... 2-6

Figure 2-3

Possible RAM Card Configurations for 4-Slot 3B2 Computers ..... 2-7

Figure 2-4

Front Side of a 256-Kilobyte RAM Card ..... 2-9

Figure 2-5

Back Side of a 2-Megabyte RAM Card ..... 2-10

Figure 3-1

Removing Cable Access Door — 12-slot 3B2 Computer ..... 3-4

Figure 3-2

Inside View of the 12-Slot 3B2 Computer ..... 3-5

Figure 3-3

Possible RAM Card Configurations for 12-Slot 3B2 Computer ..... 3-6



# INDEX

---

Figure 3-4	
Front Side of a 2-Megabyte RAM Card .....	3-8
Figure 3-5	
Back Side of a 2-Megabyte RAM Card .....	3-9

## H

HARDWARE INSTALLATION AND REMOVAL — 12-slot 3B2 Computer .	3-2
HARDWARE INSTALLATION AND REMOVAL — 4-Slot 3B2 Computer ..	2-3
Hardware Problems .....	4-5
HARDWARE REQUIREMENTS — 12-Slot 3B2 Computer .....	3-1
HARDWARE REQUIREMENTS — 4-slot Computer .....	2-1

## I

identification number on memory cards .....	1-6
IMPORTANT REMINDERS .....	1-8
installation in 12-slot 3B2 Computer .....	3-2
installation in 4-Slot 3B2 Computer .....	2-3

## L

list of parts .....	1-7
---------------------	-----

## M

MANUAL ORGANIZATION .....	1-5
memory card identification numbers .....	1-6
memory configurations for 12-slot 3B2 Computers .....	1-4
memory configurations for 4-slot 3B2 Computers .....	1-2

**P**

parts list ..... 1-6  
Possible Problems ..... 4-2  
PREPARATION — 12-slot 3B2 Computer ..... 3-2  
PREPARATION — 4-Slot 3B2 Computer ..... 2-2

**R**

removal from 12-slot 3B2 Computer ..... 3-2  
removal from 4-Slot 3B2 Computer ..... 2-3

**S**

Safety ..... 1-8  
SOFTWARE INSTALLATION AND REMOVAL — 12-slot 3B2 Computer. 3-11  
SOFTWARE INSTALLATION AND REMOVAL — 4-slot 3B2 Computer.. 2-12  
SOFTWARE REQUIREMENTS — 12-Slot 3B2 Computer ..... 3-1  
SOFTWARE REQUIREMENTS — 4-Slot 3B2 Computer ..... 2-2

**T**

TESTING ..... 4-1  
TROUBLESHOOTING ..... 4-2

**U**

UNPACKING INSTRUCTIONS ..... 1-5

Your comments and suggestions are appreciated and will help us to provide the best documentation for your use.

1. How would you rate this document for COMPLETENESS? (Please Circle)

Excellent Adequate Poor  
4 -----3 -----2 -----1 -----0

2. Identify any information that you feel should be included or removed.

\_\_\_\_\_  
\_\_\_\_\_

3. How would you rate this document for ACCURACY of information? (Please Circle)

Excellent Adequate Poor  
4 -----3 -----2 -----1 -----0

4. Specify page and nature of any error(s) found in this document.

\_\_\_\_\_  
\_\_\_\_\_

5. How would you rate this document for ORGANIZATION of information? (Please Circle)

Excellent Adequate Poor  
4 -----3 -----2 -----1 -----0

6. Describe any format or packaging problems you have experienced with this document.

\_\_\_\_\_  
\_\_\_\_\_

7. Do you have any general comments or suggestions regarding this document?

\_\_\_\_\_  
\_\_\_\_\_

8. We would like to know a little about your background as a user of this document:

- A. Your job function \_\_\_\_\_
- B. Number of years experience with computer hardware: operation \_\_\_\_\_ ,  
maintenance \_\_\_\_\_ .
- C. Number of years experience with computer software: user \_\_\_\_\_ ,  
programmer \_\_\_\_\_ .

Your Name \_\_\_\_\_ Phone No. \_\_\_\_\_  
Company \_\_\_\_\_  
Address \_\_\_\_\_  
City & State \_\_\_\_\_ Zip Code \_\_\_\_\_



NO POSTAGE  
NECESSARY  
IF MAILED  
IN THE  
UNITED STATES

**BUSINESS REPLY MAIL**

FIRST CLASS PERMIT NO. 1999 GREENSBORO, N.C.

POSTAGE WILL BE PAID BY ADDRESSEE



**DOCUMENTATION SERVICES**  
**2400 Reynolda Road**  
**Winston-Salem, N.C. 27106-9989**



.....  
Do Not Tear—Fold Here and Tape

305-532